

风扇按键/风扇开关 LTA-LSA

ZH 安装指南

147702-04



Germany
GEZE Sonderkonstruktionen GmbH
Plancken 1
97944 Boxberg-Schweigern
Tel. +49 (0) 7930 9294 0
Fax +49 (0) 7930 9294 10
E-Mail: sk.de@geze.com
GEZE GmbH
Niederlassung Süd-West
Tel. +49 (0) 7152 203 594
E-Mail: leonberg.de@geze.com
GEZE GmbH
Niederlassung Süd-Ost
Tel. +49 (0) 7152 203 6440
E-Mail: muenchen.de@geze.com
GEZE GmbH
Niederlassung Ost
Tel. +49 (0) 7152 203 6840
E-Mail: berlin.de@geze.com
GEZE GmbH
Niederlassung Mitte/Luxemburg
Tel. +49 (0) 7152 203 6888
E-Mail: frankfurt.de@geze.com
GEZE GmbH
Niederlassung West
Tel. +49 (0) 7152 203 6770
E-Mail: essen.de@geze.com
GEZE GmbH
Niederlassung Nord
Tel. +49 (0) 7152 203 6600
E-Mail: hamburg.de@geze.com
GEZE Service GmbH
Tel. +49 (0) 1802 923392
E-Mail: service-info.de@geze.com

Austria
GEZE Austria
E-Mail: austria.at@geze.com
www.geze.at

Baltic States
GEZE GmbH Baltic States office
E-Mail: office-latvia@geze.com
www.geze.com

Benelux
GEZE Benelux B.V.
E-Mail: benelux.nl@geze.com
www.geze.be
www.geze.nl

Bulgaria
GEZE Bulgaria - Trade
E-Mail: office-bulgaria@geze.com
www.geze.bg

China
GEZE Industries (Tianjin) Co., Ltd.
E-Mail: chinasales@geze.com.cn
www.geze.com.cn
GEZE Industries (Tianjin) Co., Ltd.
Branch Office Shanghai
E-Mail: chinasales@geze.com.cn
www.geze.com.cn
GEZE Industries (Tianjin) Co., Ltd.
Branch Office Guangzhou
E-Mail: chinasales@geze.com.cn
www.geze.com.cn
GEZE Industries (Tianjin) Co., Ltd.
Branch Office Beijing
E-Mail: chinasales@geze.com.cn
www.geze.com.cn

France
GEZE France S.A.R.L.
E-Mail: france.fr@geze.com
www.geze.fr

Hungary
GEZE Hungary Kft.
E-Mail: office-hungary@geze.com
www.geze.hu

Iberia
GEZE Iberia S.R.L.
E-Mail: info@geze.es
www.geze.es

India
GEZE India Private Ltd.
E-Mail: office-india@geze.com
www.geze.in

Italy
GEZE Italia S.r.l
E-Mail: italia.it@geze.com
www.geze.it
GEZE Engineering Roma S.r.l
E-Mail: roma@geze.biz
www.geze.it

Poland
GEZE Polska Sp.z o.o.
E-Mail: geze.pl@geze.com
www.geze.pl

Romania
GEZE Romania S.R.L.
E-Mail: office-romania@geze.com
www.geze.ro

Russia
OOO GEZE RUS
E-Mail: office-russia@geze.com
www.geze.ru

Scandinavia - Sweden
GEZE Scandinavia AB
E-Mail: sverige.se@geze.com
www.geze.se

Scandinavia - Norway
GEZE Scandinavia AB avd. Norge
E-Mail: norge.se@geze.com
www.geze.no

Scandinavia - Denmark
GEZE Danmark
E-Mail: danmark.se@geze.com
www.geze.dk

Singapore
GEZE (Asia Pacific) Pte, Ltd.
E-Mail: gezessea@geze.com.sg
www.geze.com

South Africa
GEZE Distributors (Pty) Ltd.
E-Mail: info@gezesa.co.za
www.geze.co.za

Switzerland
GEZE Schweiz AG
E-Mail: schweiz.ch@geze.com
www.geze.ch

Turkey
GEZE Kapi ve Pencere Sistemleri
E-Mail: office-turkey@geze.com
www.geze.com

Ukraine
LLC GEZE Ukraine
E-Mail: office-ukraine@geze.com
www.geze.ua

United Arab Emirates/GCC
GEZE Middle East
E-Mail: gezeme@geze.com
www.geze.ae

United Kingdom
GEZE UK Ltd.
E-Mail: info.uk@geze.com
www.geze.com

GEZE GmbH
Reinhold-Vöster-Straße 21-29
71229 Leonberg
Germany

Tel.: 0049 7152 203 0
Fax: 0049 7152 203 310
www.geze.com



名称

风扇按键/风扇开关, 单层框架 AS 500 阿尔卑斯白,
材料编号: 118476

配件

名称	材料编号
AS 500 暗框架	
▫ 单层	115376
▫ 双层	115377
▫ 三层	115378
▫ 四层	115379
▫ 五层	115380
AS 500 明框架	
▫ 单层	120503
▫ 双层	128609
▫ 三层	133206
用于 ST 550 的中间框架 55×55, 阿尔卑斯白	155851
用于 LS 990 的中间框架 55×55, 阿尔卑斯白	148997
用于 LS 990 的中间框架 55×55, 不锈钢	131822
AS 500 遮光罩 BAB	118480
SCT (单极)	117996

合适的开关程序

Jung

- AS 500
- LS 990 (带中间框架)
- ST550 (带中间框架)

Merten

- 系统 M

Berker

- B3
- B7
- S1

Gira

- 标准 55
- E2
- Event

Feller

- EDIZIOdue

技术数据

型号	电压	电流
LTA-LSA	230 V AC	最高 10 A
保护类型	IP 40	

尺寸图

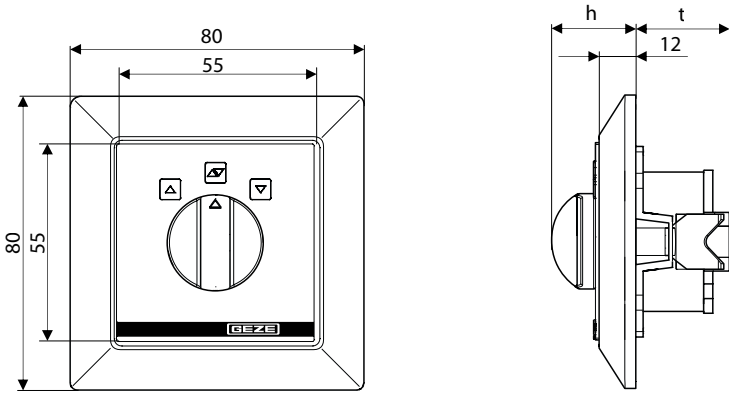

组装

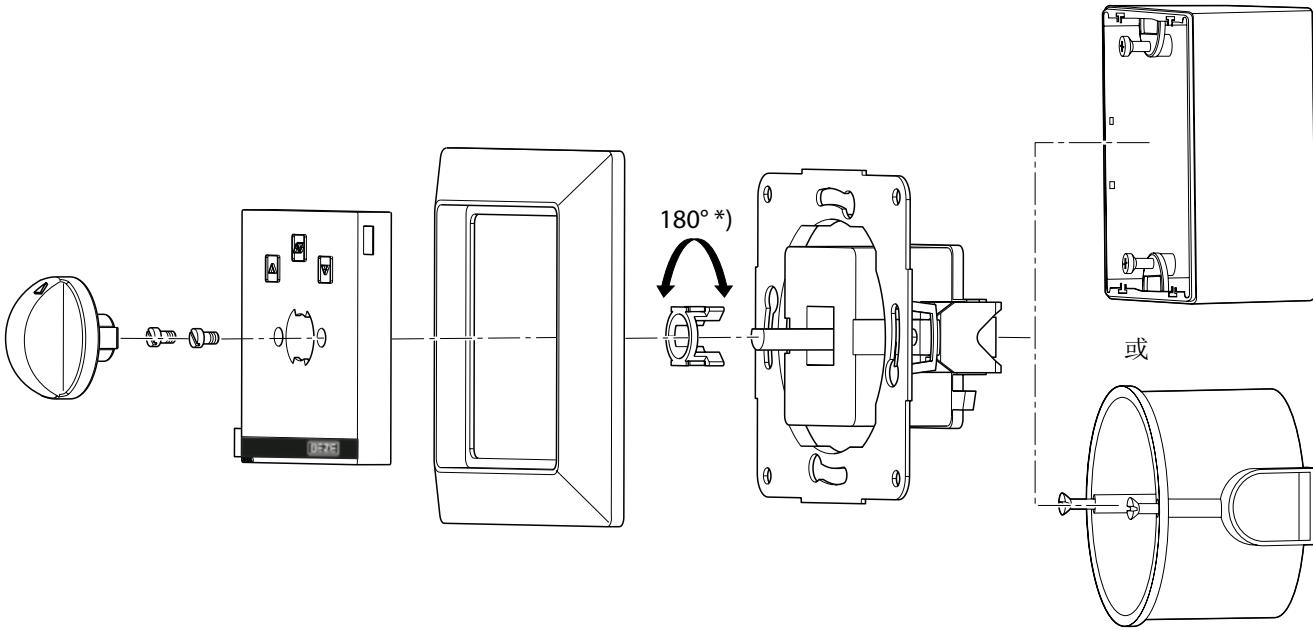

*) 可选配的触摸或卡止功能；
供货状态：卡止

支柱安装模板

- ❗ 纸质模板的尺寸可以根据空气湿度进行调整。因此只需要遵守尺寸规定。
 - ▶ 在使用纸质模板之前，检查尺寸，必要时予以校正。

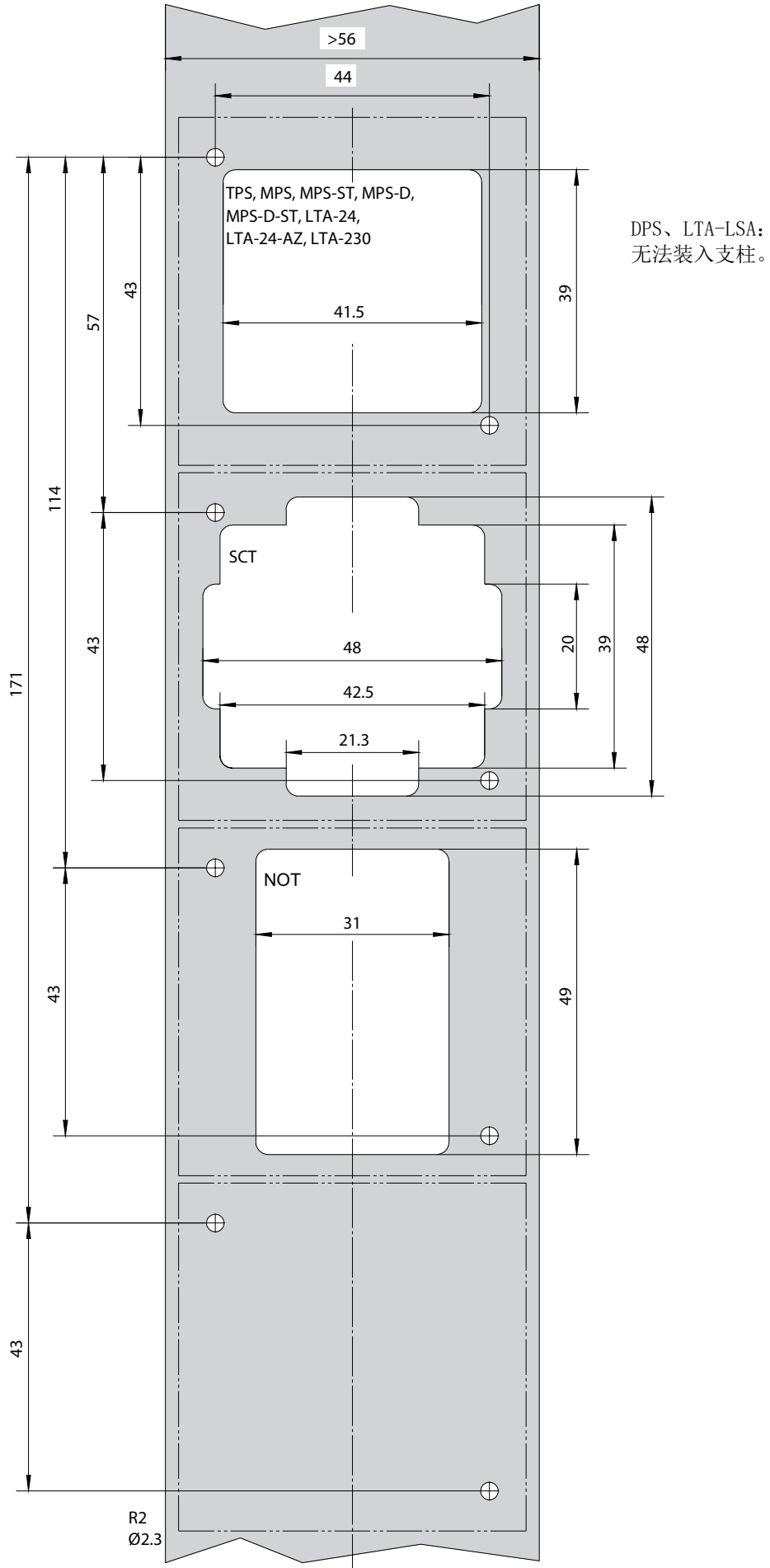

电路图

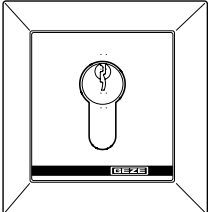
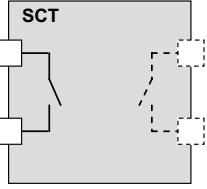
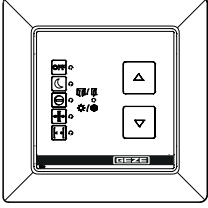
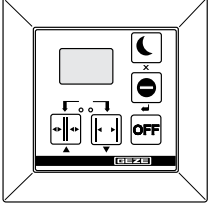
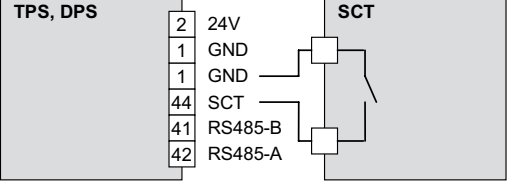
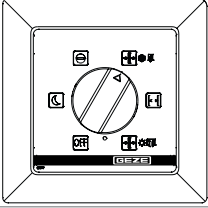
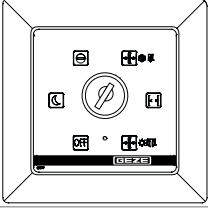
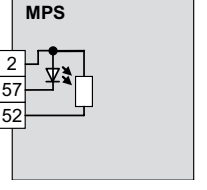
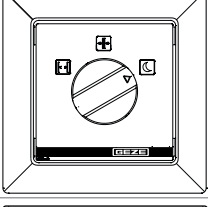
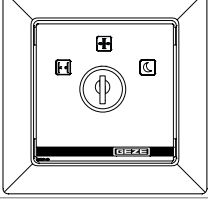
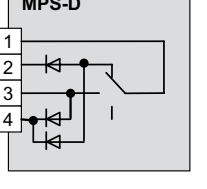
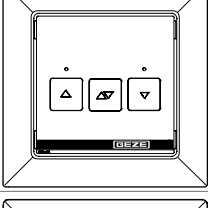
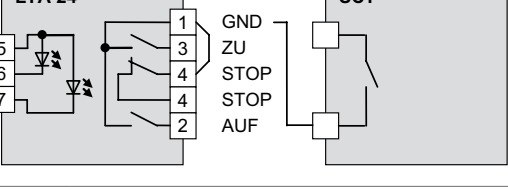
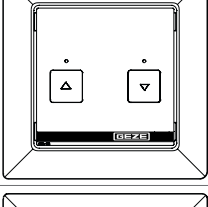
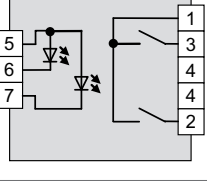
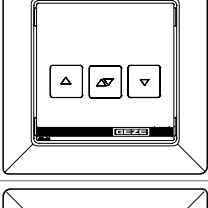
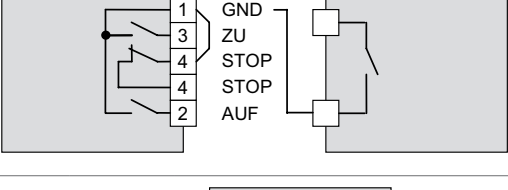
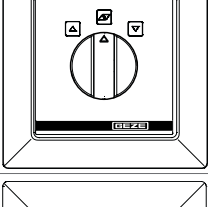
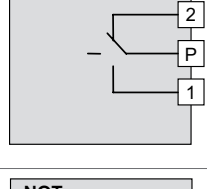
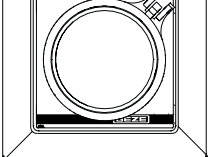
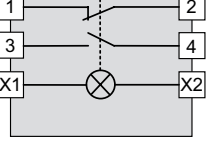
按键	名称	材料编号	按键	名称	材料编号	电路图	高 [mm]	深 [mm]
	SCT (单极)	117996		-	-		11	31.9
	TPS TPS-SCT TPS-KDT TPS-KDT-SCT DPS 带 关闭功能 DPS 无 关闭功能 DPS 带 关闭功能 DPS 带 关闭功能 SCT	113231 113232 126582 126583 151524 155809 155810					11.3	5.3 31.9
	MPS	113226		MPS-ST	113227		24	36
	MPS-D	118417		MPS-D-ST	118418		24	36
	LTA-24 LTA-24-SCT	118473 127176					11	26
	LTA-24-AZ	129393					11	26
	LTA-230 LTA-230-SCT	118474 118475					11	26
	LTA-LSA	118476					24	32
	NOT	123132					54	56