

风扇按键 LTA

ZH 安装指南

147689-05



Germany
 GEZE Sonderkonstruktionen GmbH
 Planken 1
 97944 Boxberg-Schweigert
 Tel. +49 (0) 7930 9294 0
 Fax +49 (0) 7930 9294 10
 E-Mail: sk.de@geze.com
 GEZE GmbH
 Niederlassung Süd-West
 Tel. +49 (0) 7152 203 594
 E-Mail: leonberg.de@geze.com
 GEZE GmbH
 Niederlassung Süd-Ost
 Tel. +49 (0) 7152 203 6440
 E-Mail: muenchen.de@geze.com
 GEZE GmbH
 Niederlassung Ost
 Tel. +49 (0) 7152 203 6840
 E-Mail: berlin.de@geze.com
 GEZE GmbH
 Niederlassung Mitte/Luxemburg
 Tel. +49 (0) 7152 203 6888
 E-Mail: frankfurt.de@geze.com
 GEZE GmbH
 Niederlassung West
 Tel. +49 (0) 7152 203 6770
 E-Mail: essen.de@geze.com
 GEZE GmbH
 Niederlassung Nord
 Tel. +49 (0) 7152 203 6600
 E-Mail: hamburg.de@geze.com
 GEZE Service GmbH
 Tel. +49 (0) 1802 923392
 E-Mail: service-info.de@geze.com

Austria
 GEZE Austria
 E-Mail: austria.at@geze.com
 www.geze.at

Baltic States
 GEZE GmbH Baltic States office
 E-Mail: office-latvia@geze.com
 www.geze.com

Benelux
 GEZE Benelux B.V.
 E-Mail: benelux.nl@geze.com
 www.geze.be
 www.geze.nl

Bulgaria
 GEZE Bulgaria - Trade
 E-Mail: office-bulgaria@geze.com
 www.geze.bg

China
 GEZE Industries (Tianjin) Co., Ltd.
 E-Mail: chinasales@geze.com.cn
 www.geze.com.cn

GEZE Industries (Tianjin) Co., Ltd.
 Branch Office Shanghai
 E-Mail: chinasales@geze.com.cn
 www.geze.com.cn

GEZE Industries (Tianjin) Co., Ltd.
 Branch Office Guangzhou
 E-Mail: chinasales@geze.com.cn
 www.geze.com.cn

GEZE Industries (Tianjin) Co., Ltd.
 Branch Office Beijing
 E-Mail: chinasales@geze.com.cn
 www.geze.com.cn

France
 GEZE France S.A.R.L.
 E-Mail: france.fr@geze.com
 www.geze.fr

Hungary
 GEZE Hungary Kft.
 E-Mail: office-hungary@geze.com
 www.geze.hu

Iberia
 GEZE Iberia S.R.L.
 E-Mail: info@geze.es
 www.geze.es

India
 GEZE India Private Ltd.
 E-Mail: office-india@geze.com
 www.geze.in

Italy
 GEZE Italia S.r.l.
 E-Mail: italia.it@geze.com
 www.geze.it

GEZE Engineering Roma S.r.l.
 E-Mail: roma@geze.biz
 www.geze.it

Poland
 GEZE Polska Sp. z o.o.
 E-Mail: geze.pl@geze.com
 www.geze.pl

Romania
 GEZE Romania S.R.L.
 E-Mail: office-romania@geze.com
 www.geze.ro

Russia
 OOO GEZE RUS
 E-Mail: office-russia@geze.com
 www.geze.ru

Scandinavia – Sweden
 GEZE Scandinavia AB
 E-Mail: sverige.se@geze.com
 www.geze.se

Scandinavia – Norway
 GEZE Scandinavia AB avd. Norge
 E-Mail: norge.se@geze.com
 www.geze.no

Scandinavia – Denmark
 GEZE Danmark
 E-Mail: danmark.se@geze.com
 www.geze.dk

Singapore
 GEZE (Asia Pacific) Pte, Ltd.
 E-Mail: gezeasia@geze.com.sg
 www.geze.com

South Africa
 GEZE Distributors (Pty) Ltd.
 E-Mail: info@gezesa.co.za
 www.geze.co.za

Switzerland
 GEZE Schweiz AG
 E-Mail: schweiz.ch@geze.com
 www.geze.ch

Turkey
 GEZE Kapi ve Pencere Sistemleri
 E-Mail: office-turkey@geze.com
 www.geze.com

Ukraine
 LLC GEZE Ukraine
 E-Mail: office-ukraine@geze.com
 www.geze.ua

United Arab Emirates/GCC
 GEZE Middle East
 E-Mail: gezeme@geze.com
 www.geze.ae

United Kingdom
 GEZE UK Ltd.
 E-Mail: info.uk@geze.com
 www.geze.com

型号

名称	材料编号
风扇按键 LTA-24, LED 灯, 单层框架 AS 500, 阿尔卑斯白	118473
风扇按键 LTA24-AZ, LED 灯, 单层框架 AS 500, 阿尔卑斯白	129393
风扇按键 LTA-24-SCT, 带钥匙操作按键, 单极, 无异形半圆柱锁芯, 带双层框架 AS 500, 阿尔卑斯白	127176
风扇按键 LTA-230, 单层框架 AS 500 阿尔卑斯白	118474
风扇按键 LTA-230-SCT, 带钥匙操作按键, 单极, 无异形半圆柱锁芯, 带双层框架 AS 500, 阿尔卑斯白	118475

配件

名称	材料编号
AS 500 暗框架	
□ 单层	115376
□ 双层	115377
□ 三层	115378
□ 四层	115379
□ 五层	115380

GEZE GmbH
 Reinhold-Vöster-Straße 21–29
 71229 Leonberg
 Germany
 Tel.: 0049 7152 203 0
 Fax: 0049 7152 203 310
 www.geze.com



名称	材料编号
AS 500 明框架	
□ 单层	120503
□ 双层	128609
□ 三层	133206
用于 ST 550 的中间框架 55×55, 阿尔卑斯白	155851
用于 LS 990 的中间框架 55×55, 阿尔卑斯白	148997
用于 LS 990 的中间框架 55×55, 不锈钢	131822
AS 500 遮光罩 BAB	118480
异形半圆柱锁芯	090176
SCT (单极)	117996
开关触点	024467

合适的开关程序

Jung	Berker
□ AS 500	□ B3
□ LS 990 (带中间框架)	□ B7
□ ST550 (带中间框架)	
Merten	S1 Gira
□ 系统 M	□ 标准 55
	□ E2
	□ Event
	Feller
	□ EDIZI0due

技术数据

型号	电压	电流
LTA-24	24 V DC	0.05 A
LTA-24-AZ	24 V DC	0.05 A
LTA-230	230 V AC	6 A
保护类型	IP 40	

尺寸图

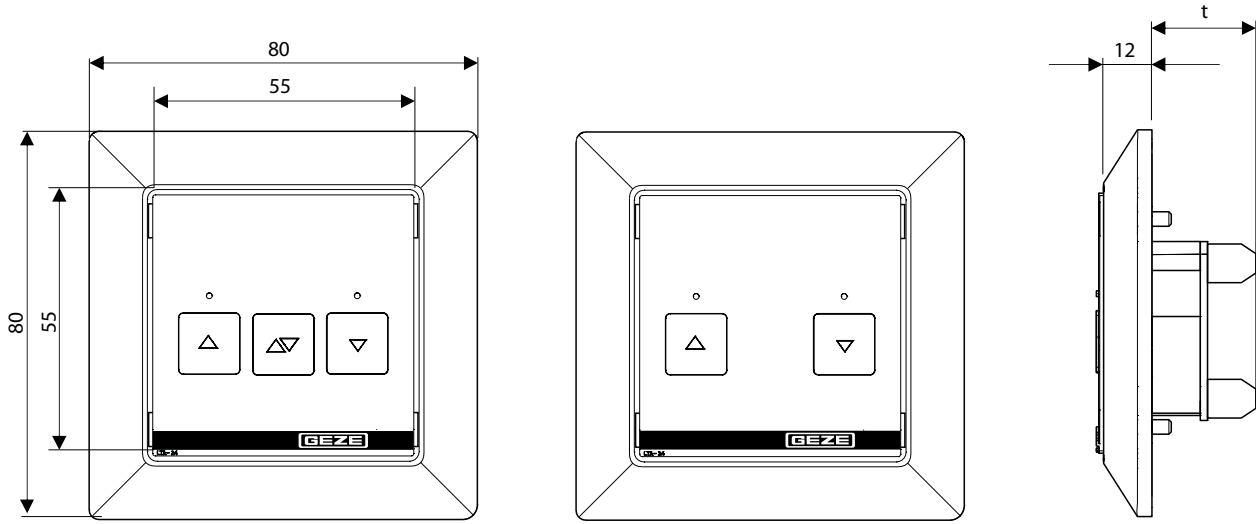

组装

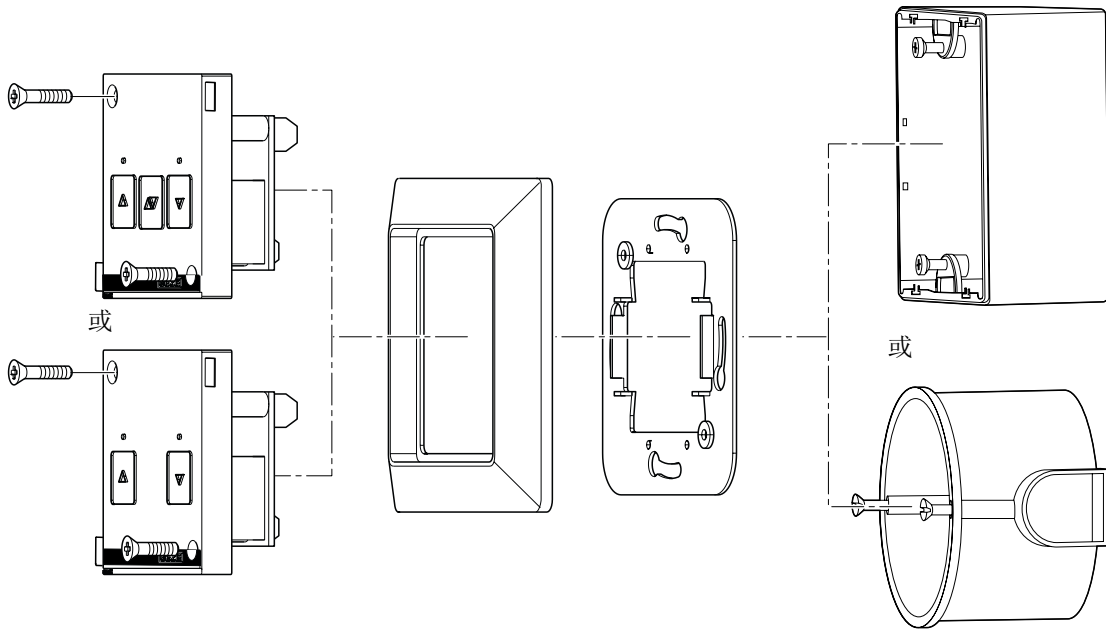

支柱安装模板

- ❗ 纸质模板的尺寸可以根据空气湿度进行调整。因此只需要遵守尺寸规定。
 - ▶ 在使用纸质模板之前，检查尺寸，必要时予以校正。

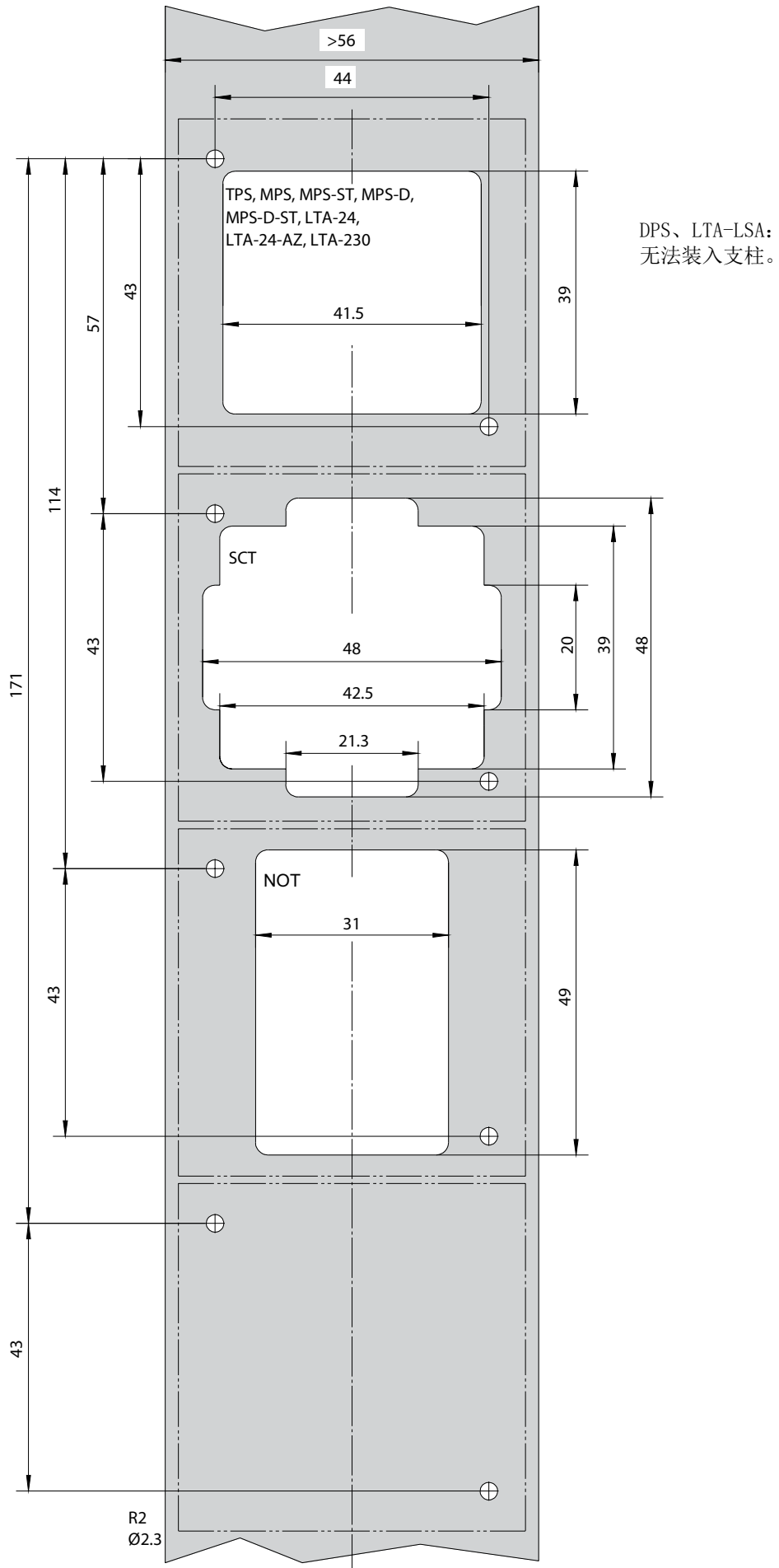

电路图

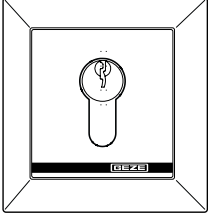
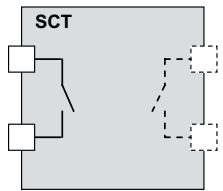
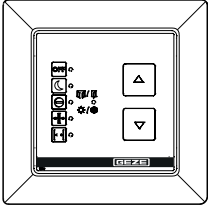
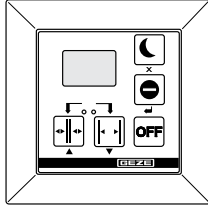
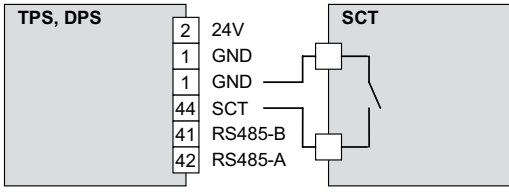
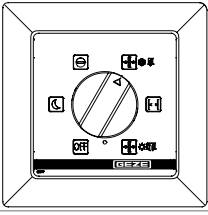
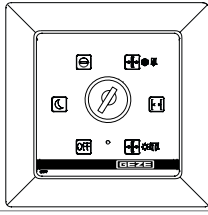
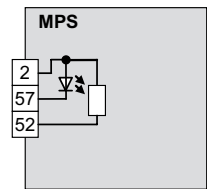
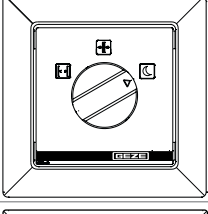
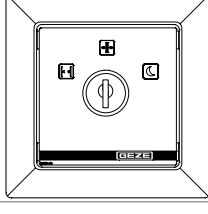
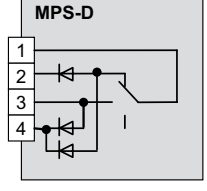
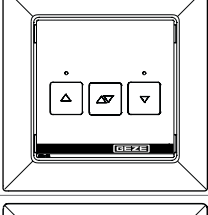
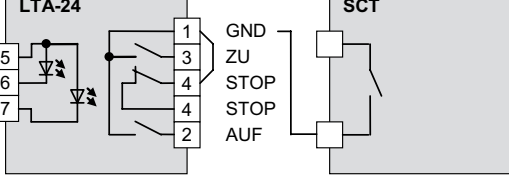
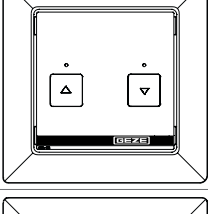
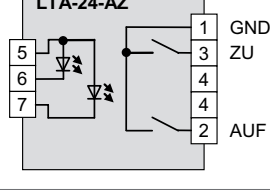
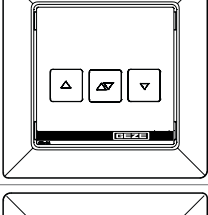
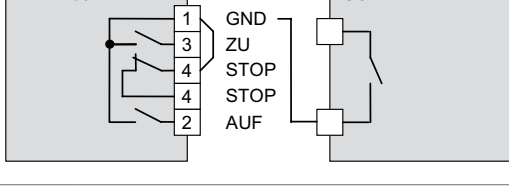
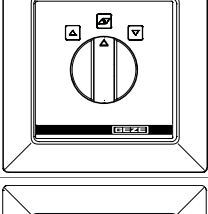
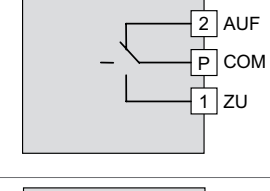
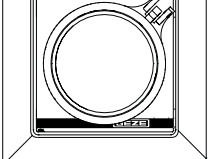
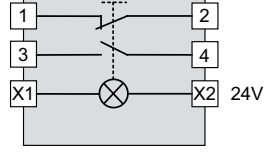
按键	名称	材料编号	按键	名称	材料编号	电路图	高 [mm]	深 [mm]
	SCT (单极)	117996		-	-		11	31.9
	TPS TPS-SCT TPS-KDT TPS-KDT-SCT DPS 带 关闭功能 DPS 无 关闭功能 DPS 带 关闭功能 DPS 带 关闭功能 SCT	113231 113232 126582 126583 151524 155809 155810					11.3	5.3 31.9
	MPS	113226		MPS-ST	113227		24	36
	MPS-D	118417		MPS-D-ST	118418		24	36
	LTA-24 LTA-24-SCT	118473 127176					11	26
	LTA-24-AZ	129393					11	26
	LTA-230 LTA-230-SCT	118474 118475					11	26
	LTA-LSA	118476					24	32
	NOT	123132					54	56