

## 钥匙开关 SCT

ZH 安装指南

159800-04



**Germany**  
 GEZE GmbH  
 Niederlassung Süd-West  
 Tel. +49 (0) 7152 203 594  
 E-Mail: leonberg.de@geze.com  
 GEZE GmbH  
 Niederlassung Süd-Ost  
 Tel. +49 (0) 7152 203 6440  
 E-Mail: muenchen.de@geze.com  
 GEZE GmbH  
 Niederlassung Ost  
 Tel. +49 (0) 7152 203 6840  
 E-Mail: berlin.de@geze.com  
 GEZE GmbH  
 Niederlassung Mitte/Luxemburg  
 Tel. +49 (0) 7152 203 6888  
 E-Mail: frankfurt.de@geze.com  
 GEZE GmbH  
 Niederlassung West  
 Tel. +49 (0) 7152 203 6770  
 E-Mail: duesseldorf.de@geze.com  
 GEZE GmbH  
 Niederlassung Nord  
 Tel. +49 (0) 7152 203 6600  
 E-Mail: hamburg.de@geze.com  
 GEZE Service GmbH  
 Tel. +49 (0) 1802 923392  
 E-Mail: service-info.de@geze.com

**Austria**  
 GEZE Austria  
 E-Mail: austria.at@geze.com  
 www.geze.at  
**Baltic States**  
 Lithuania / Latvia / Estonia  
 E-Mail: baltic-states@geze.com  
**Benelux**  
 GEZE Benelux B.V.  
 E-Mail: benelux.nl@geze.com  
 www.geze.be  
 www.geze.nl  
**Bulgaria**  
 GEZE Bulgaria - Trade  
 E-Mail: office-bulgaria@geze.com  
 www.geze.bg

**China**  
 GEZE Industries (Tianjin) Co., Ltd.  
 E-Mail: chinasales@geze.com.cn  
 www.geze.com.cn  
 GEZE Industries (Tianjin) Co., Ltd.  
 Branch Office Shanghai  
 E-Mail: chinasales@geze.com.cn  
 www.geze.com.cn  
 GEZE Industries (Tianjin) Co., Ltd.  
 Branch Office Guangzhou  
 E-Mail: chinasales@geze.com.cn  
 www.geze.com.cn  
 GEZE Industries (Tianjin) Co., Ltd.  
 Branch Office Beijing  
 E-Mail: chinasales@geze.com.cn  
 www.geze.com.cn

**France**  
 GEZE France S.A.R.L.  
 E-Mail: france.fr@geze.com  
 www.geze.fr  
**Hungary**  
 GEZE Hungary Kft.  
 E-Mail: office-hungary@geze.com  
 www.geze.hu

**Iberia**  
 GEZE Iberia S.R.L.  
 E-Mail: info.es@geze.com  
 www.geze.es

**India**  
 GEZE India Private Ltd.  
 E-Mail: office-india@geze.com  
 www.geze.in

**Italy**  
 GEZE Italia S.r.l.  
 E-Mail: italia.it@geze.com  
 www.geze.it

GEZE Engineering Roma S.r.l.  
 E-Mail: italia.it@geze.com  
 www.geze.it

**Korea**  
 GEZE Korea Ltd.  
 E-Mail: info.kr@geze.com  
 www.geze.com

**Poland**  
 GEZE Polska Spz o.o.  
 E-Mail: geze.pl@geze.com  
 www.geze.pl

**Romania**  
 GEZE Romania S.R.L.  
 E-Mail: office-romania@geze.com  
 www.geze.ro

**Russia**  
 OOO GEZE RUS  
 E-Mail: office-russia@geze.com  
 www.geze.ru

**Scandinavia Sweden**  
 GEZE Scandinavia AB  
 E-Mail: sverige.se@geze.com  
 www.geze.se

**Scandinavia Norway**  
 GEZE Scandinavia AB avd. Norge  
 E-Mail: norge.se@geze.com  
 www.geze.no

**Scandinavia Denmark**  
 GEZE Danmark  
 E-Mail: danmark.se@geze.com  
 www.geze.dk

**Singapore**  
 GEZE (Asia Pacific) Pte. Ltd.  
 E-Mail: gezesea@geze.com.sg  
 www.geze.com

**South Africa**  
 GEZE South Africa (Pty) Ltd.  
 E-Mail: info@gezesa.co.za  
 www.geze.co.za

**Switzerland**  
 GEZE Schweiz AG  
 E-Mail: schweiz.ch@geze.com  
 www.geze.ch

**Turkey**  
 GEZE Kapi ve Pencere Sistemleri  
 E-Mail: office-turkey@geze.com  
 www.geze.com

**Ukraine**  
 LLC GEZE Ukraine  
 E-Mail: office-ukraine@geze.com  
 www.geze.ua

**United Arab Emirates/GCC**  
 GEZE Middle East  
 E-Mail: gezeme@geze.com  
 www.geze.ae

**United Kingdom**  
 GEZE UK Ltd.  
 E-Mail: info.uk@geze.com  
 www.geze.com

**GEZE GmbH**  
 Reinhold-Vöster-Straße 21-29 Tel.: 0049 7152 203 0  
 71229 Leonberg Fax: 0049 7152 203 310  
 Germany www.geze.com



## 标识

该钥匙开关的作用是让已授权人员能够使用 GEZE 操作终端或生成一个控制信号。

- 钥匙开关, 单极并含单层框架 AS 500 阿尔卑斯白, 无半锁芯, 材料编号: 117996

## 安全提示

请注意门机的安全提示

## 配件

名称	材料编号
AS 500 暗框架	
□ 单层	115376
□ 双层	115377
□ 三层	115378
□ 四层	115379
□ 五层	115380
AS 500 明装底盒	
□ 单层	120503
□ 双层	128609
□ 三层	133206
用于 ST 550 的中间框架 55×55, 阿尔卑斯白	155851
用于 LS 990 的中间框架 55×55, 阿尔卑斯白	148997
用于 LS 990 的中间框架 55×55, 不锈钢	131822
AS 500 暗盖	115402
半锁芯	090176
开关触点	024467

## 匹配的开关产品

Jung

- AS 500
- LS 990 (带中间框架)
- ST550 (带中间框架)

Merten

- System M

Berker

- B3
- B7
- S1

Gira

- Standard 55
- E2
- Event

Feller

- EDIZIOdue

## 技术参数

- 开关电压:
- 开断电流:
- 防护等级:

最高 240 V AC

最高 4 A

IP 40

## 标准

- DIN 18 252 - 门锁用欧标型材锁芯

# 比例图

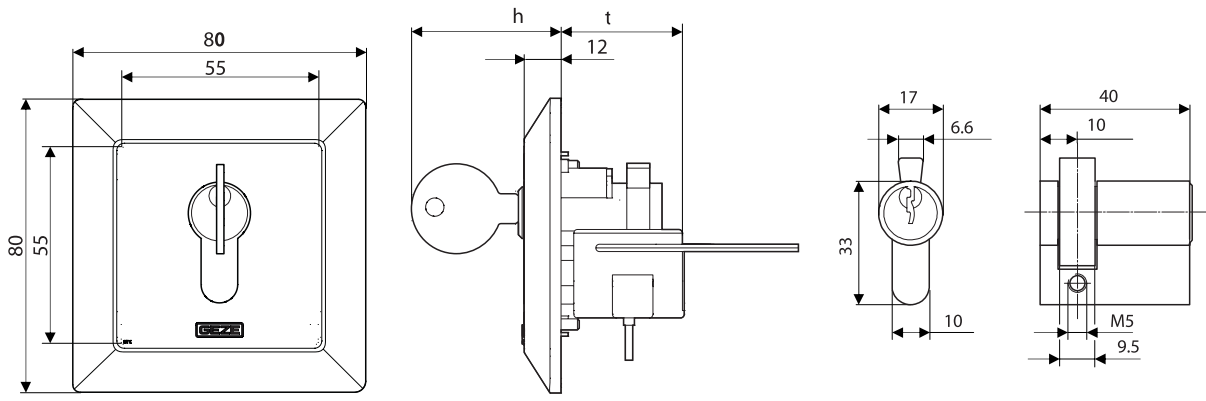

# 组装

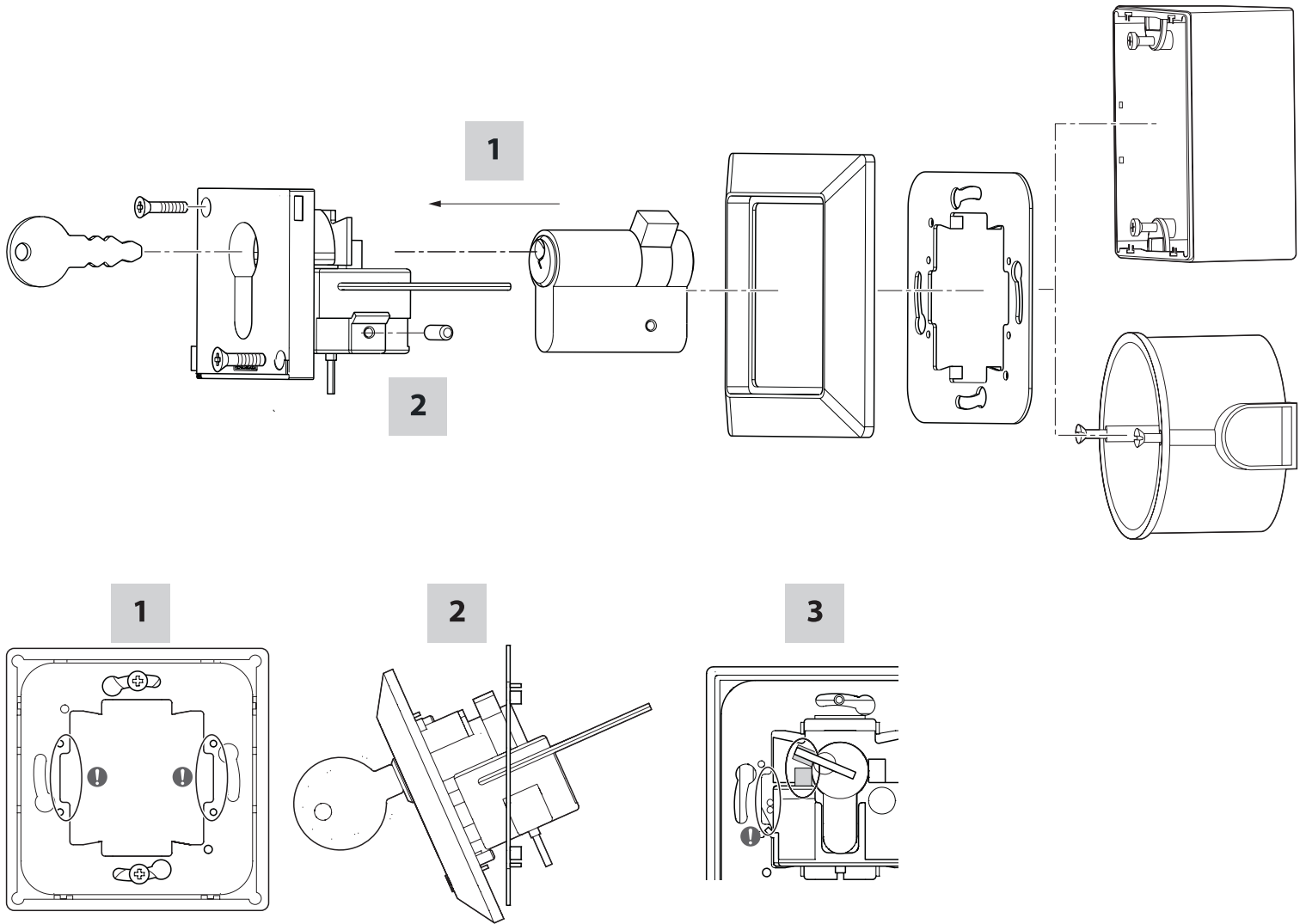

# 立柱装配用孔板, 无框架

❗ 纸质孔板会因为空气湿度而有所变形。因此, 这里的数据仅供参考。  
▶ 请在使用前检查纸质孔板的尺寸并在必要时修改。

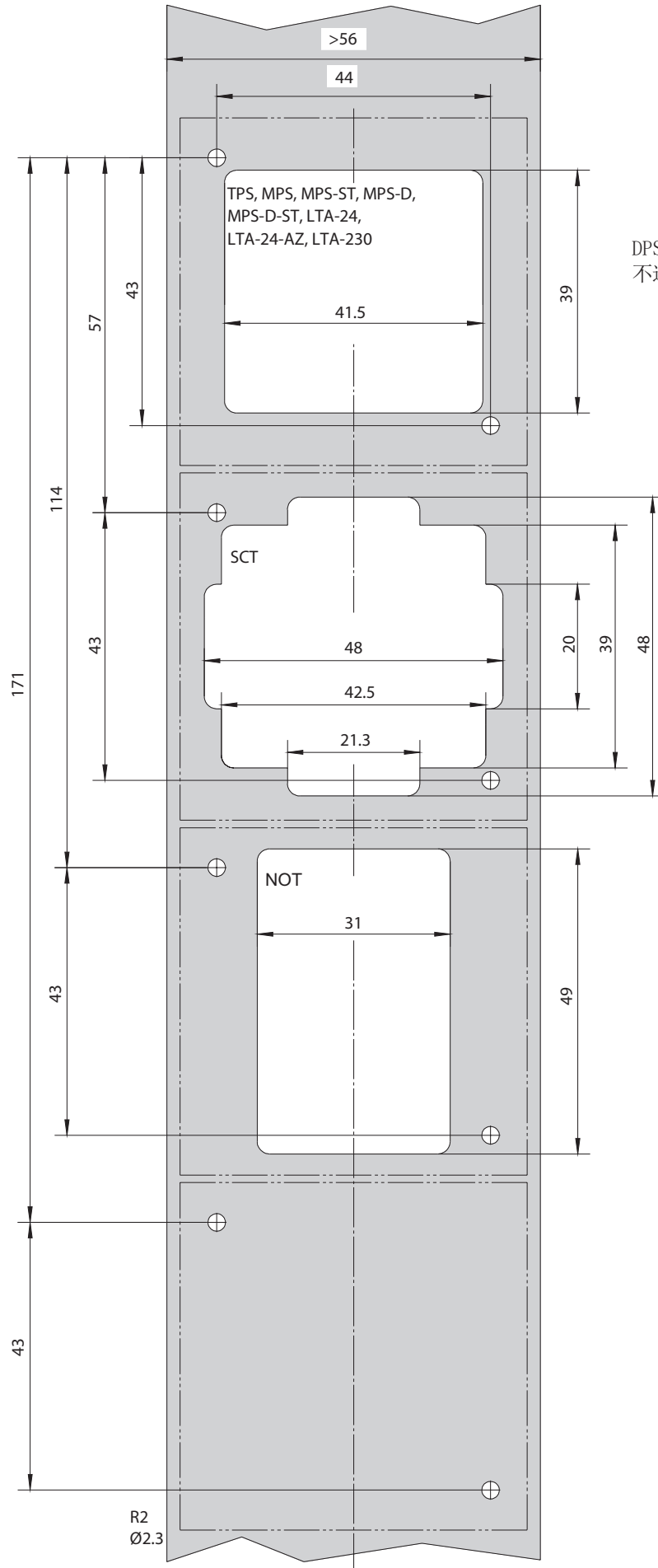

DPS, LTA-LSA:  
不适合在立柱上安装。

# 电路图

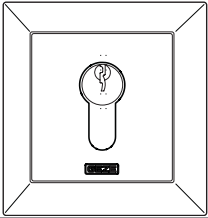
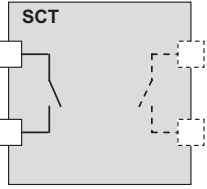
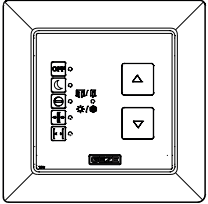
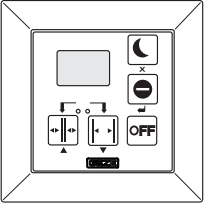
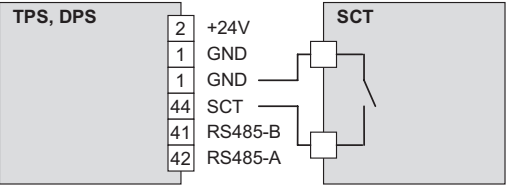
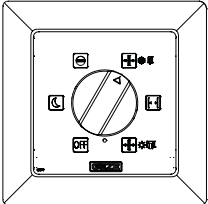
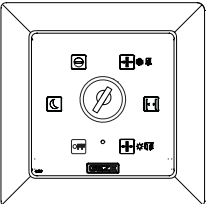
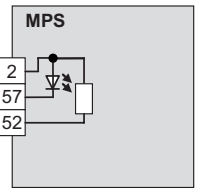
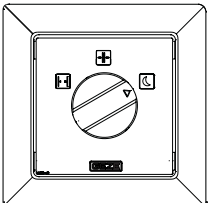
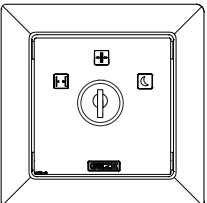
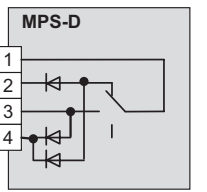
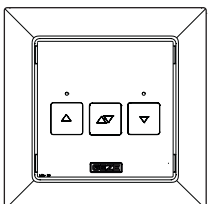
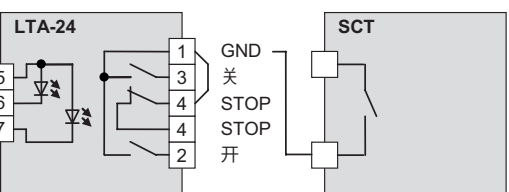
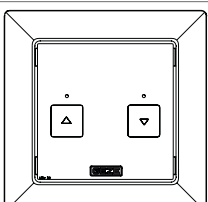
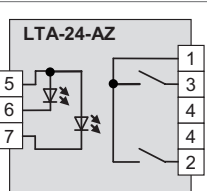
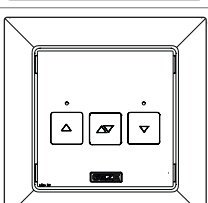
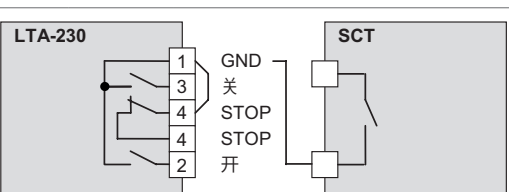
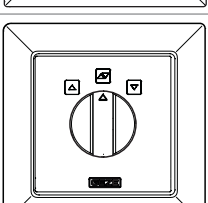
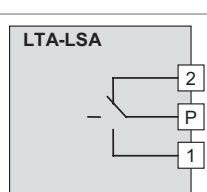
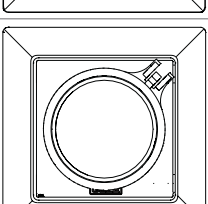
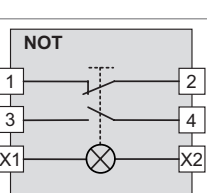
按钮	标识	材料编号	按钮	标识	材料编号	电路图	高 [mm]	深 [mm]
	SCT (1 极)	117996		-	-		11	31.9
	按键程序开关 TPS	113231					11.3	5.3
	TPS-SCT	113232						
	TPS-KDT	126582						
	TPS-KDT-SCT	126583						
	DPS 带 OFF	151524						31.9
	DPS 不带 OFF	155809						
	DPS 带 OFF SCT	155810						
	MPS	113226		MPS-ST	113227		24	36
	MPS-D	118417		MPS-D-ST	118418		24	36
	LTA-24	118473					11	26
	LTA-24-SCT	127176						
	LTA-24-AZ	129393					11	26
	LTA-230	118474					11	26
	LTA-230-SCT	118475						
	LTA-LSA	118476					24	32
	NOT	123132					54	56