

## 按键程序开关 TPS

DE 安装指南

159813-04



**Germany**  
 GEZE GmbH  
 Niederlassung Süd-West  
 Tel. +49 (0) 7152 203 594  
 E-Mail: leonberg.de@geze.com  
 GEZE GmbH  
 Niederlassung Süd-Ost  
 Tel. +49 (0) 7152 203 6440  
 E-Mail: muenchen.de@geze.com  
 GEZE GmbH  
 Niederlassung Ost  
 Tel. +49 (0) 7152 203 6840  
 E-Mail: berlin.de@geze.com  
 GEZE GmbH  
 Niederlassung Mitte/Luxemburg  
 Tel. +49 (0) 7152 203 6888  
 E-Mail: frankfurt.de@geze.com  
 GEZE GmbH  
 Niederlassung West  
 Tel. +49 (0) 7152 203 6770  
 E-Mail: duesseldorf.de@geze.com  
 GEZE GmbH  
 Niederlassung Nord  
 Tel. +49 (0) 7152 203 6600  
 E-Mail: hamburg.de@geze.com  
 GEZE Service GmbH  
 Tel. +49 (0) 1802 923392  
 E-Mail: service-info.de@geze.com

**Austria**  
 GEZE Austria  
 E-Mail: austria.at@geze.com  
 www.geze.at  
**Baltic States**  
 Lithuania / Latvia / Estonia  
 E-Mail: baltic-states@geze.com  
**Benelux**  
 GEZE Benelux B.V.  
 E-Mail: benelux.nl@geze.com  
 www.geze.be  
 www.geze.nl  
**Bulgaria**  
 GEZE Bulgaria - Trade  
 E-Mail: office-bulgaria@geze.com  
 www.geze.bg

**China**  
 GEZE Industries (Tianjin) Co., Ltd.  
 E-Mail: chinasales@geze.com.cn  
 www.geze.com.cn  
 GEZE Industries (Tianjin) Co., Ltd.  
 Branch Office Shanghai  
 E-Mail: chinasales@geze.com.cn  
 www.geze.com.cn  
 GEZE Industries (Tianjin) Co., Ltd.  
 Branch Office Guangzhou  
 E-Mail: chinasales@geze.com.cn  
 www.geze.com.cn  
 GEZE Industries (Tianjin) Co., Ltd.  
 Branch Office Beijing  
 E-Mail: chinasales@geze.com.cn  
 www.geze.com.cn

**France**  
 GEZE France S.A.R.L.  
 E-Mail: france.fr@geze.com  
 www.geze.fr  
**Hungary**  
 GEZE Hungary Kft.  
 E-Mail: office-hungary@geze.com  
 www.geze.hu

**Iberia**  
 GEZE Iberia S.R.L.  
 E-Mail: info.es@geze.com  
 www.geze.es

**India**  
 GEZE India Private Ltd.  
 E-Mail: office-india@geze.com  
 www.geze.in

**Italy**  
 GEZE Italia S.r.l.  
 E-Mail: italia.it@geze.com  
 www.geze.it

GEZE Engineering Roma S.r.l.  
 E-Mail: italia.it@geze.com  
 www.geze.it

**Korea**  
 GEZE Korea Ltd.  
 E-Mail: info.kr@geze.com  
 www.geze.com

**Poland**  
 GEZE Polska Spz o.o.  
 E-Mail: geze.pl@geze.com  
 www.geze.pl

**Romania**  
 GEZE Romania S.R.L.  
 E-Mail: office-romania@geze.com  
 www.geze.ro

**Russia**  
 OOO GEZE RUS  
 E-Mail: office-russia@geze.com  
 www.geze.ru

**Scandinavia Sweden**  
 GEZE Scandinavia AB  
 E-Mail: sverige.se@geze.com  
 www.geze.se

**Scandinavia Norway**  
 GEZE Scandinavia AB avd. Norge  
 E-Mail: norge.se@geze.com  
 www.geze.no

**Scandinavia Denmark**  
 GEZE Danmark  
 E-Mail: danmark.se@geze.com  
 www.geze.dk

**Singapore**  
 GEZE (Asia Pacific) Pte. Ltd.  
 E-Mail: gezeasia@geze.com.sg  
 www.geze.com

**South Africa**  
 GEZE South Africa (Pty) Ltd.  
 E-Mail: info@gezeza.co.za  
 www.geze.co.za

**Switzerland**  
 GEZE Schweiz AG  
 E-Mail: schweiz.ch@geze.com  
 www.geze.ch

**Turkey**  
 GEZE Kapi ve Pencere Sistemleri  
 E-Mail: office-turkey@geze.com  
 www.geze.com

**Ukraine**  
 LLC GEZE Ukraine  
 E-Mail: office-ukraine@geze.com  
 www.geze.ua

**United Arab Emirates/GCC**  
 GEZE Middle East  
 E-Mail: gezeme@geze.com  
 www.geze.ae

**United Kingdom**  
 GEZE UK Ltd.  
 E-Mail: info.uk@geze.com  
 www.geze.com

**GEZE GmbH**  
 Reinhold-Vöster-Straße 21-29 Tel.: 0049 7152 203 0  
 71229 Leonberg Fax: 0049 7152 203 310  
 Germany www.geze.com



## 名称

按键程序开关, 用于自动门系统的运行模式切换。

- 按键程序开关, 含单层框架 AS 500 阿尔卑斯白, 材料编号 113231
- 按键程序开关, 带钥匙开关, 单极不带半锁芯, 含双层框架 AS 500 阿尔卑斯白, 材料编号 113232

## 安全提示

请注意门机的安全提示

## 配件

| 名称                           | 材料编号   |
|------------------------------|--------|
| AS 500 隐藏框架                  |        |
| □ 单层                         | 115376 |
| □ 双层                         | 115377 |
| □ 三层                         | 115378 |
| □ 四层                         | 115379 |
| □ 五层                         | 115380 |
| AS 500 明装底盒                  |        |
| □ 单层                         | 120503 |
| □ 双层                         | 128609 |
| □ 三层                         | 133206 |
| 用于 ST 550 的中间框架 55×55, 阿尔卑斯白 | 155851 |
| 用于 LS 990 的中间框架 55×55, 阿尔卑斯白 | 148997 |
| 用于 LS 990 的中间框架 55×55, 不锈钢   | 131822 |
| AS 500 暗盖                    | 115402 |
| 半锁芯                          | 090176 |
| 开关触点                         | 024467 |

## 匹配的开关产品

- Jung
- AS 500
  - LS 990 (带中间框架)
  - ST550 (带中间框架)
  - Merten
  - System M
- Berker
- B3
  - B7
  - S1
- Gira
- Standard 55
  - E2
  - Event
- Feller
- EDIZIOdue

## 技术参数

- 电压: 24 V DC
- 电流: 50 mA
- 导线长度, 最大: 100 m
- 防护等级: IP 40
- 存储: -20 °C ... 85 °C  
无结露
- 运行时的环境温度: -15 °C ... +50 °C
- EMC 电磁兼容, 符合: EN 61000-6-2

## 比例图

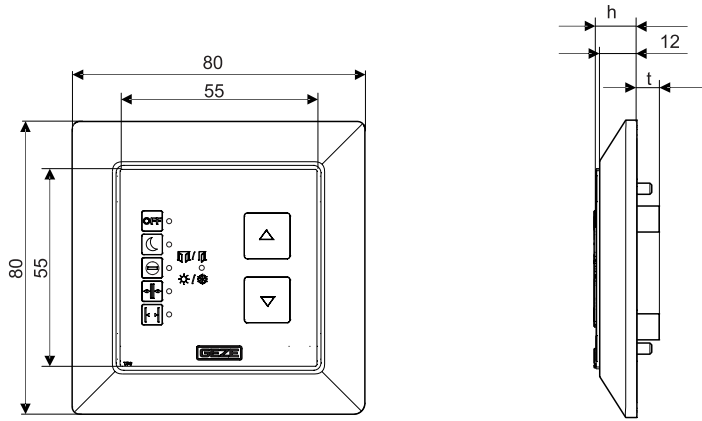

## 组装

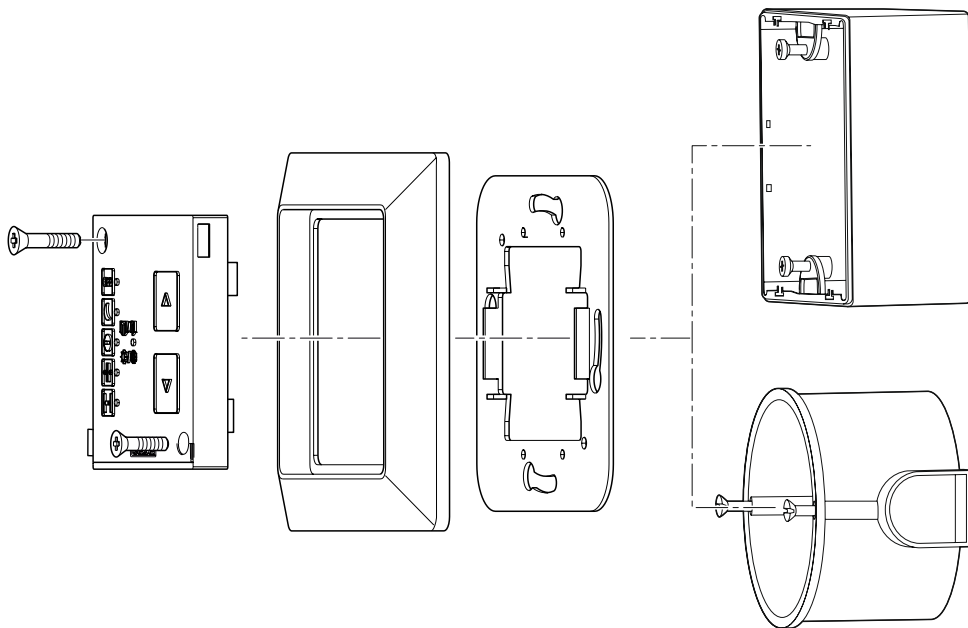

# 立柱装配用孔板, 无框架

❗ 纸质孔板会因为空气湿度而有所变形。因此, 这里的数据仅供参考。  
▶ 请在使用前检查纸质孔板的尺寸并在必要时修改。

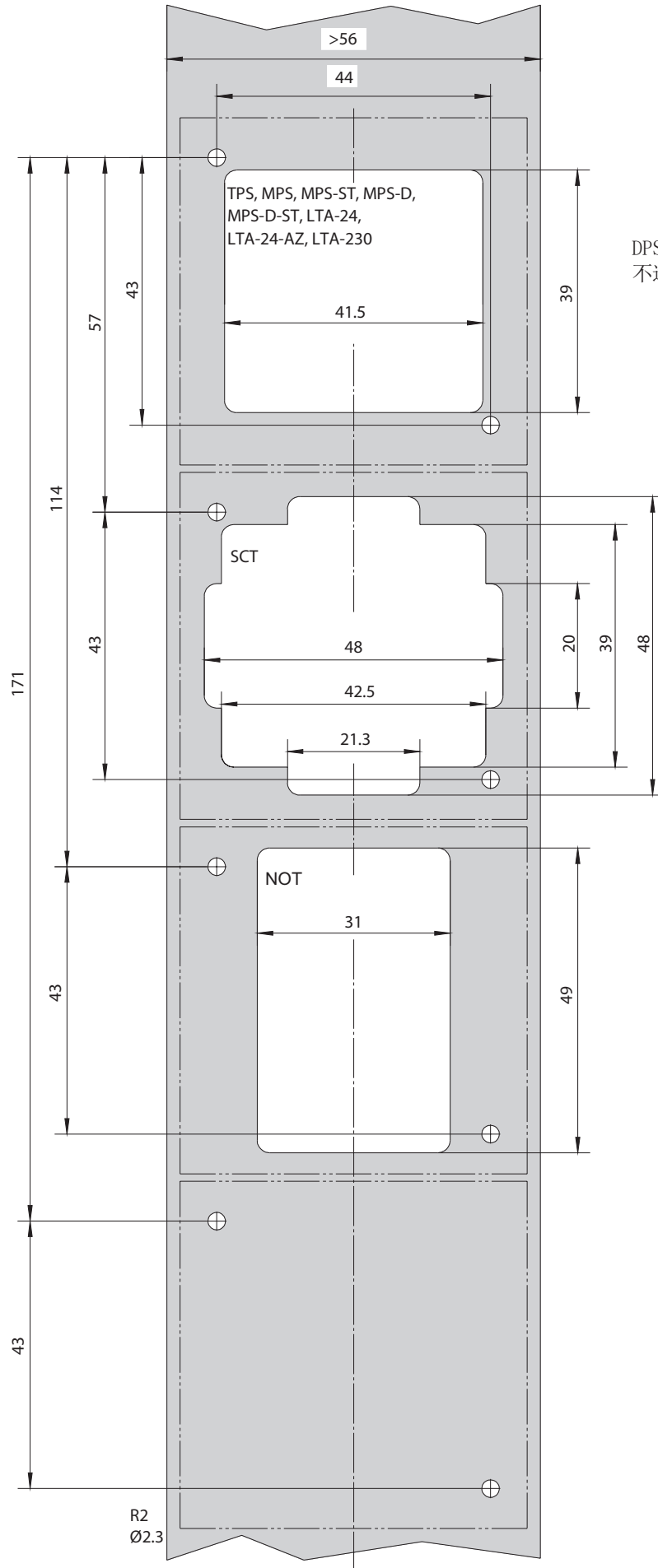

# 电路图

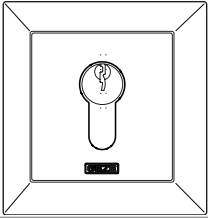
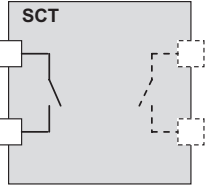
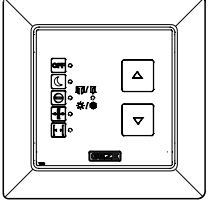
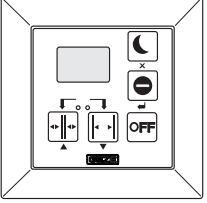
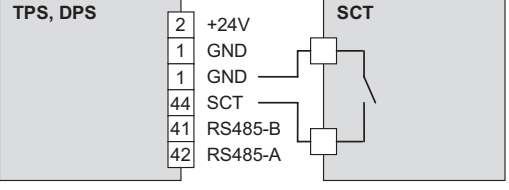
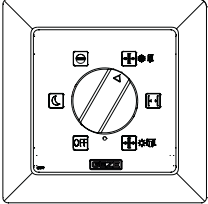
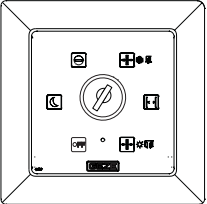
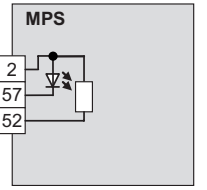
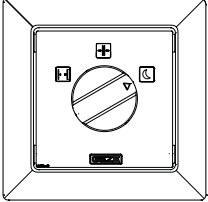
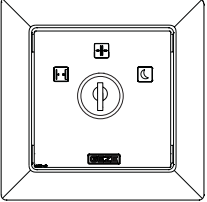
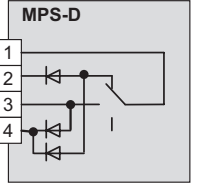
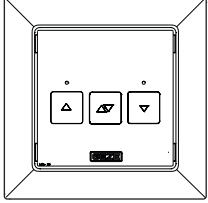
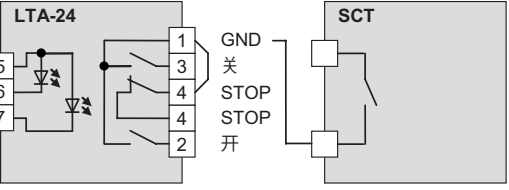
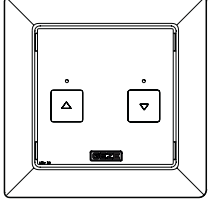
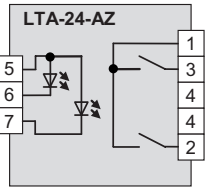
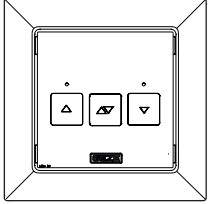
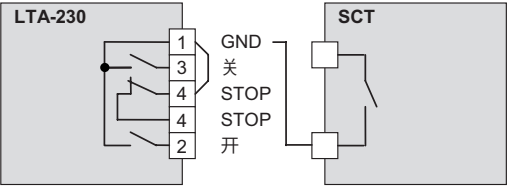
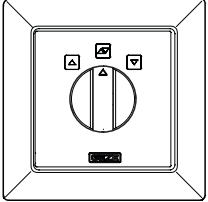
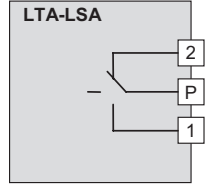
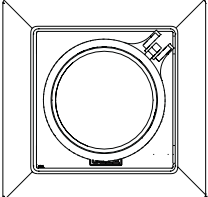
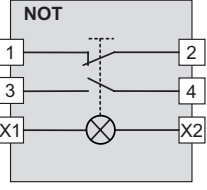
| 开关   | 标识               | 材料编号   | 开关   | 描述       | 材料编号   | 电路图   | 高 [mm] | 深 [mm] |
|--|------------------|--------|--|----------|--------|---|--------|--------|
|    | SCT (1 极)        | 117996 |  | -        | -      |    | 11     | 31.9   |
|    | 按键式键程序<br>开关 TPS | 113231 |   |          |        |     | 11.3   | 5.3    |
|  | TPS-SCT          | 113232 |  |          |        |   |        |        |
|  | TPS-KDT          | 126582 |  |          |        |   |        |        |
|  | TPS-KDT-SCT      | 126583 |  |          |        |   |        |        |
|  | DPS 带 OFF        | 151524 |  |          |        |   |        | 31.9   |
|  | DPS 不带 OFF       | 155809 |  |          |        |   |        |        |
|  | DPS 带 OFF SCT    | 155810 |  |          |        |   |        |        |
|    | MPS              | 113226 |   | MPS-ST   | 113227 |    | 24     | 36     |
|   | MPS-D            | 118417 |  | MPS-D-ST | 118418 |   | 24     | 36     |
|  | LTA-24           | 118473 |  |          |        |   |        |        |
|  | LTA-24-SCT       | 127176 |  |          |        |   | 11     | 26     |
|  | LTA-24-AZ        | 129393 |  |          |        |  | 11     | 26     |
|  | LTA-230          | 118474 |  |          |        |   |        |        |
|  | LTA-230-SCT      | 118475 |  |          |        |   | 11     | 26     |
|  | LTA-LSA          | 118476 |  |          |        |  | 24     | 32     |
|  | NOT              | 123132 |  |          |        |  | 54     | 56     |